

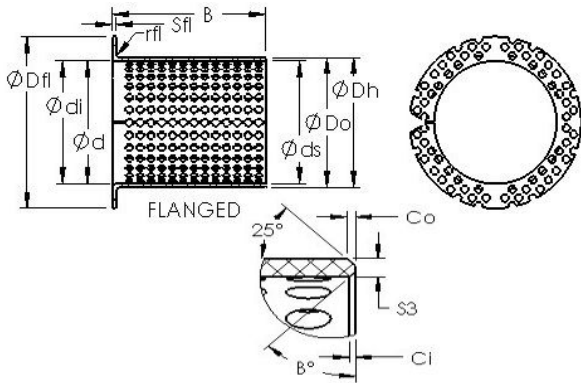

BEARING-SINGAPORE (PTE)LTD.



AST ASTT90 F2515 plain bearings

Bearing No. ASTT90 F2515

Bore Diameter	25 mm
Outer Diameter	28 mm
Bearing Type	flanged
Shaft Dia., Nominal (d)	25.0000
Shaft Size (ds) - 25 -0.065 / -0.086	25 0.065 / 0.086
Housing Bore Dia. (Dh) - 28 +0.021 / -0	28 +0.021 / 0
Bearing Outside Diameter, Nominal(Do)	28.000
Bearing Bore after Mounting (di) - 25 +0.052 / -0	25 +0.052 / 0
Wall Thickness (S3)	1.500
Bearing Length, Nominal (B)	15.000
Bearing Length Tolerance (B tol.) - +0 / -0.40	+0 / 0.40
OD Chamfer Length (Co)	0.700
ID Chamfer Angle (B deg.)	35
ID Chamfer Length (Ci)	0.500
Flange Dia. (Dfl pm 0.5)	35.000
Flange Thickness (Sfl)	1.500
Flange Radius (rfl)	1.000
Material	Wrapped bronze with lubrication holes.

ASTT90 F2515 Bearing 2D drawings and 3D CAD models