

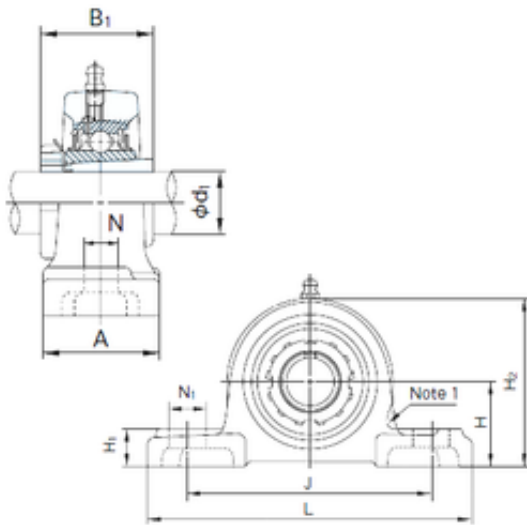

BEARING-SINGAPORE (PTE)LTD.

NACHI UKP306+H2306 bearing units

Bearing No. UKP306+H2306



UKP306+H2306 Bearing 2D drawings and 3D CAD models

Bore Diameter	25 mm
Width	50 mm
d	25 mm
A	50 mm
B1	38 mm
H	50 mm
H1	19 mm
H2	94 mm
J	140 mm
L	180 mm
N	17 mm
N1	20 mm
Bolt (G)	M14